

LT-3200 Series Installation Guide

Caution

Be sure to read the “Warning/Caution Information” on the attached sheet before using the product.

Package Contents

- (1) LT Unit (1)
- (2) English and Japanese Installation Guides (one of each) <This Guide>
- (3) Warning/Caution Information (1)
- (4) English and Japanese EX Module Hardware Manual *1 (1)
- (5) Installation Gasket (1, attached to the LT unit)
- (6) Installation Fasteners (Set of 4)



- (7) DIO Connector (1)



- (8) Power Connector (1)



- (9) USB Cable Clamp (1 set)
(Holder: 1, Cover: 1)



*1 The EX module is an extension I/O unit for the LT 3000 series. To use the EX module, be sure to read the supplied manual.

This unit has been carefully packed, with special attention to quality. However, should you find anything damaged or missing, please contact your local LT distributor immediately.

About the Manual

For the detailed information on LT3000 series, refer to the following manual.

- LT3000 Series Hardware Manual
- Maintenance/Troubleshooting
- GP-Pro EX Reference Manual “Controlling External I/O”

LT3000 Series Hardware Manual can be selected from the help menu of GP-Pro EX or downloaded from Pro-face Home Page.

URL

<http://www.pro-face.com/otasuke/>

Part Names and Functions

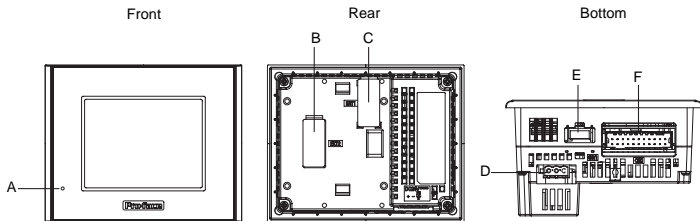

Name		Description			
A	Status LED	Color	Indicator	Operation Mode (Drawing)	Logic execution mode (when logic is enabled)
		Green	ON	OFFLINE	—
			Flashing	In operation	RUN
		Red	ON	When power is turned on.	
			Flashing	In operation	Major Error
		Orange	ON	Backlight burnout	
			Flashing	During software startup	
B	AUX Interface (EXT2)	Used to connect the additional units (communication function etc.).			
C	EX Module Interface (EXT1)	Used to connect the Digital Electronics Corporation EX Module.			
D	Power Connector	—			
E	USB Host Interface (USB)	1 port Complies with USB 1.1. Uses a "TYPE-A" connector. Power supply voltage: 5 VDC \pm 5%, Output current: 500mA (max.) The maximum communication distance: 5m			
F	DIO Interface (DIO)	Used to connect the external I/O device.			

General Specifications

■ Electrical Specifications

Power Supply	Input Voltage	DC24V
	Rated Voltage	DC19.2 to 28.8V
	Allowable Voltage Drop	10ms (max.)
	Power Consumption	18W (max.)
	In-Rush Current	30A (max.)
Voltage Endurance	AC1000V 20mA for 1minute (between charging and FG terminals)	
Insulation Resistance	DC500V 10M Ω (min.) (between charging and FG terminals)	

■ Environmental Specifications

Physical	Surrounding Operating Temperature	0 to +50°C*1
	Storage Temperature	-20 to +60°C
	Ambient Humidity	10 to 90% RH (Wet bulb temperature: 39°C max. - no condensation.)
	Storage Humidity	10 to 90% RH (Wet bulb temperature: 39°C max. - no condensation.)
	Dust	0.1mg/m ³ and below (non-conductive levels)
	Pollution Degree	For use in Pollution Degree 2 environment

*1 When using in an environment where the temperature becomes or exceeds 40°C for an extended period of time, the screen contrast level may decrease from its original level of brightness.

DIO Interface (Connector)

IMPORTANT

- When preparing the cable to connect the wiring, check the pin numbers inscribed on the DIO Connector.

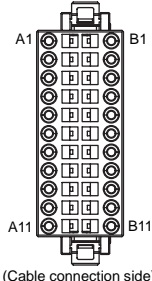
Applicable connector	2-1871940-1 <Tyco Electronics AMP.> CA6-DIOCN4-01 <Digital Electronics Corp.>			
Pin Arrangement	Pin No.	Signal Name	Pin No.	Signal Name
 <p>(Cable connection side)</p>	A1	IN1	B1	IN0 (CT0)
	A2	IN3	B2	IN2 (CT1)
	A3	IN5	B3	IN4 (CT2)
	A4	IN7	B4	IN6 (CT3)
	A5	IN9	B5	IN8
	A6	IN11	B6	IN10
	A7	NC	B7	COM
	A8	0V	B8	+24V
	A9	OUT1 (PLS1, PWM1)	B9	OUT0 (PLS0, PWM0)
	A10	OUT3 (PLS3, PWM3)	B10	OUT2 (PLS2, PWM2)
	A11	OUT5	B11	OUT4

NOTE

- Parenthesized signal names () indicate when Pulse output (PLS*), PWM output (PWM*), or Counter Input (CT*) are used.

■ Input Specifications

Rated Voltage	DC24V	
Maximum Allowable Voltage	DC28.8V	
Input Method	Sink/Source Input	
Rated Current	6.5mA (DC24V) (IN0, IN2, IN4, IN6) 5mA (DC24V) (Other input)	
Input Resistance	Approx. 3.7kΩ (IN0, IN2, IN4, IN6) Approx. 4.7kΩ (Other input)	
Input Derating	 ◆Input Derating (5 page)	
Input Points	12	
Common Lines	1	
Common Design	12 points/1 common line	
Operation Range	ON Voltage	DC19V or more
	OFF Voltage	DC5V or less
Input Delay Time*1	OFF to ON	0.5 to 20ms*2
	ON to OFF	0.5 to 20ms*2
Input Signal Display	No LED indicators	

Status Display	None
Isolation Method	Photocoupler Isolation
External Connection	22-pin connector (used with Output section)
External Power Supply	For Signal: DC 24V

*1 In the case of IN0, IN2, IN4, and IN6, the input delay time generates a 5 μ s delay.

For example, in the case of a 0.5ms-cycle sampling:

5 μ s (ON to OFF) + 0.5ms (sampling cycle) + 5 μ s (OFF to ON) = 0.51ms

A minimum 0.51ms-restriction is imposed on the input pulse width.

In the case of IN1, IN3, IN5, and from IN7 to IN11, the input delay time generates a 0.5ms-delay. For

example, in the case of a 0.5ms-cycle sampling:

0.5ms (ON to OFF) + 0.5ms (sampling cycle) + 0.5ms (OFF to ON) = 1.5ms

A minimum 1.5ms-restriction is imposed on the input-pulse width.

*2 Digital filter can be set at intervals of 0.5 ms.

◆ Input Derating

Using LT input voltage that exceeds the rated voltage, the input ON voltage, the number of input points or the LT's temperature can effect. Also, the LT's input section could overheat, which could lead to an accident or malfunction. Refer to the following drawing and perform Input Derating within the LT unit's rated range.

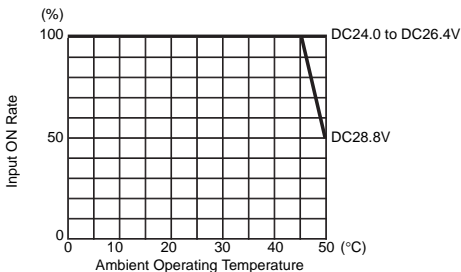

◆ Input Circuit

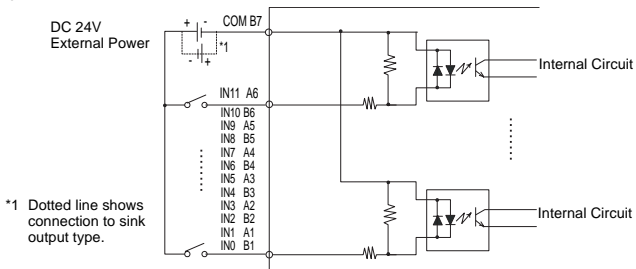

■ Output Specifications

Output Terminal		OUT0 to OUT3	OUT4 to OUT5
Rated Voltage		DC24V	
Rated Voltage Range		DC20.4V to DC28.8V	
Output Method	LT3201-A1-D24-K	Sink Output	
	LT3201-A1-D24-C	Source Output	
Maximum Load Voltage		0.2A /point, 1.2A /common	
Output Voltage Drop		DC0.5V or less	
Output Delay Time	OFF to ON	5 μ s or less (With output at DC24V, 200mA)	0.5ms or less (With output at DC24V, 200mA)
	ON to OFF	5 μ s or less (With output at DC24V, 200mA)	0.5ms or less (With output at DC24V, 200mA)
Voltage Leakage (when OFF)		0.1mA or less	
Clamp Voltage		39V \pm 1V	
Type of Output		Transistor Output	
Common Lines		1	
Common Design		6 points/1 common line	
External Connection		22-pin connector (also used for Input)	
Output Protection Type		Output is unprotected	
Internal Fuse		2.5A, 125V Chip fuse (not replaceable)	
Surge Control Circuit		Zener diode	
Output Points		6	
Output Signal Display		No LED indicators	
Status Display Element		None	
Isolation Method		Photocoupler Isolation	
External Power Supply		For Signal: DC 24V	

◆ LT3201-A1-D24-K Output Circuit (Sink type)

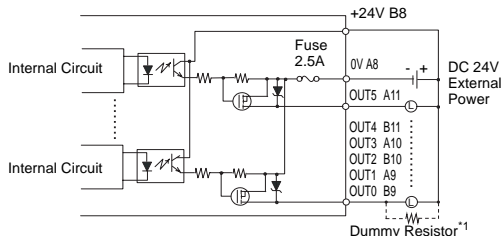

*1 (Example) The output delay time (OFF to ON) is 1.5 μ s where the output current is DC 24V, 50mA. Install an external dummy resistor to increase the amount of current when more responsiveness is required and the load is light.

NOTE

- Since the output terminals are not electrically protected, an output line might be short-circuited or a connection fault might damage the LT unit. Please install an applicable fuse to prevent an overload in the circuit, if necessary.

◆ LT3201-A1-D24-C Output Circuit (Source type)

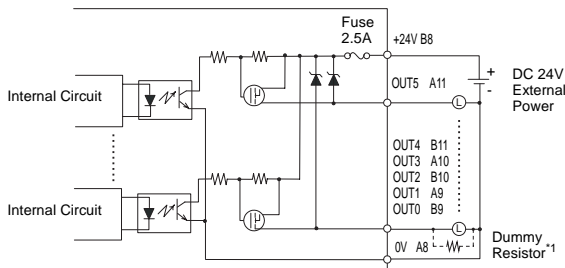

*1 (Example) The output delay time (ON to OFF) is 1.5 μ s where the output current is DC 24V, 50mA. Install an external dummy resistor to increase the amount of current when more responsiveness is required and the load is light.

NOTE

- Since the output terminals are not electrically protected, an output line might be short-circuited or a connection fault might damage the LT unit. Please install an applicable fuse to prevent an overload in the circuit, if necessary.

■ High-Speed Counter / Pulse Catch Input Specifications

DIO Standard Input/Output is used as a High-Speed Counter Input. The setup is done by the GP-Pro EX. (SEE \rightarrow) GP-Pro EX Reference Manual "Controlling External I/O"

Input	Counter		Pulse Catch
	DC24V Open Collector		DC24V Open Collector
	Single Phase (4 points)	2 Phase (1 point or 2 points)	
Input Points	CT0 (IN0), CT1 (IN2), CT2 (IN4), CT3 (IN6)	CT0 (IN0), CT1 (IN2) (used as pair) CT0: A Phase, CT1: B Phase CT2 (IN4), CT3 (IN6) (used as pair) CT2: A Phase, CT3: B Phase	IN0, IN2, IN4, IN6
High Speed Count Frequency	100Kpps	50Kpps	—
Marker Input (Counter Value Clear)	None	IN3, IN7	—

Installations

1. Installation Requirements

- For easier maintenance, operation, and improved ventilation, be sure to install the LT at least 100 mm [3.94 in.] away from adjacent structures and other equipment.

Unit:mm[in.]

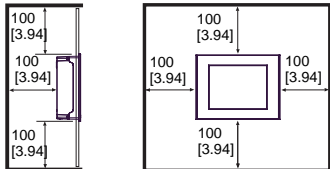

- Be sure that the surrounding air temperature and the ambient humidity are within their designated ranges. (Surrounding air temperature: 0 to 50°C, Ambient humidity: 10 to 90%RH, Wet bulb temperature: 39°C max.)

When installing the LT on the panel of a cabinet or enclosure, "Surrounding air temperature" indicates both the panel face and cabinet or enclosure's internal temperature.

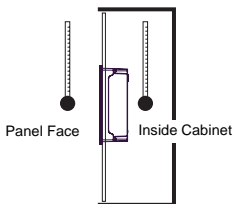

- Be sure that heat from surrounding equipment does not cause the LT to exceed its standard operating temperature.

2. LT Installation

- Create a Panel Cut following the dimensions in the table below.

Unit: mm [in.]

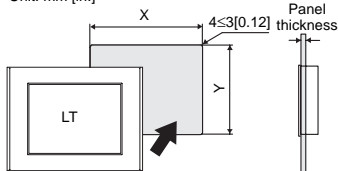

LT	X	Y	Panel thickness
LT-3201A	118.5 ⁺¹ ₋₀ [4.67 ^{+0.04} ₋₀]	92.5 ⁺¹ ₋₀ [3.64 ^{+0.04} ₋₀]	1.6[0.06] to 5.0[0.20]

- Confirm that the installation gasket is attached to the LT unit and then place the LT unit into the Panel from the front.

IMPORTANT

- It is strongly recommended that you use the installation gasket, since it absorbs vibration in addition to repelling water.

For the procedure for replacing the installation gasket, refer to "LT3000 Series Hardware Manual".

- The following figures show the four (4) fastener insertion slot locations. Insert each fastener's hook into the slot and tighten it with a screwdriver. Insert the installation fasteners securely into the insertion slot recess.

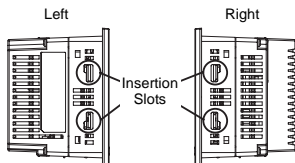

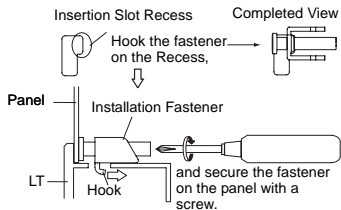

■ DIO Cable Specifications

DIO Cable Diameter	AWG24 to 18 UL1015 or UL1007
Conductor Type	Stranded Wire *1
Conductor Length	7 mm [0.28in]

*1 If the Conductor's end (individual) wires are not twisted correctly, the end wires may either short against each other, or against an electrode.

■ Connecting the DIO Cable

- (1) Insert a flathead screwdriver, at an angle, into the tool insertion hole (square-shaped hole) of the connector.
- (2) When inserting the flathead screw driver, be sure that it is perpendicular to the center division wall.

IMPORTANT

- Tightening the screws with too much force can damage the LT unit's plastic case.
- The necessary torque is 0.5N•m.
- Be sure to insert installation fasteners in the recessed portion of a installation fasteners hole. If the fasteners are not correctly attached, the LT unit may shift or fall out of the panel.

3. Wiring to the DIO Connector

IMPORTANT

- Be sure to remove the DIO Connector from the LT unit prior to starting wiring. Failure to do so may cause an electric shock.

■ Items Required to Wire Connectors Screwdriver

Recommended type: 1891348-1 <Tyco Electronics AMP.>

If another manufacturer is used, be sure the part has the following dimensions:

point depth: 1.5mm [0.06in.]

point width: 2.4mm [0.09in.]

Point shape should be DIN5264A, and meet Security Standard DN EN60900.

Also, the screwdriver's tip should be flat as indicated in order to access the narrow hole of the connector:



NOTE

- Make the insertion distance of the flathead screwdriver approximately 4 mm. Inserting forcefully may break the inside of the connector and will a cause of contact defect.

Also, do not turn the flathead screwdriver while the tip is inside of the tool insertion hole (square-shaped hole).

- (3) The adjacent wire insertion hole (round-shaped hole) will be in an open state. With the flathead screwdriver still inserted, insert the wire into the wire insertion hole (round-shaped hole).

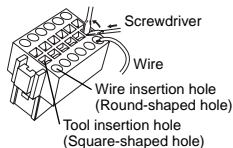

- (4) Remove the flathead screwdriver from the tool insertion hole (square-shaped hole). The wire insertion hole (round-shaped hole) will close and the wire will be secured. In the case of wire removal, remove the desired wire by inserting a flathead screwdriver into the corresponding tool insertion hole (square-shaped hole) following procedures (1) and (2).
- (5) Insert the wired DIO connector straight into the DIO I/F of the LT unit.

IMPORTANT

- Be sure to strip only the amount of cover required. If too much cover is removed, the end wires may short against each other, or against an electrode, which can create an electric shock. If not enough cover is removed the wire cannot carry a charge.
- Do not solder the wire itself. This could lead to a bad or poor contact.
- Insert each wire completely into its opening. Failure to do so can lead to a unit malfunction or short, either against wire filaments, or against an electrode.
- When wiring, be aware of the installation position, direction, and twisting of the wiring as to not develop stress on the connector. Fix the cable near the LT by cable clamp and set it loosely as to not place tension on the connector.

Wiring

⚠ WARNING

- To avoid an electric shock, prior to connecting the LT unit's power cord terminals to the power terminal block, confirm that the LT unit's power supply is completely turned OFF, via a breaker, or similar unit.
- Any other power level can damage both the LT and the power supply.
- When the FG terminal is connected, be sure the wire is grounded.

1. Wiring the DC type power supply cable

■ Power Cord Specifications

Use copper conductors only.

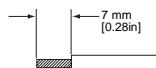
Power Cord Diameter	0.75 to 2.5mm ² (18 - 12 AWG)
Conductor Type	Simple or Stranded Wire*1
Conductor Length	

*1 If the Conductor's end (individual) wires are not twisted correctly, the end wires may either short against each other, or against an electrode.

■ Power Connector (Plug) Specifications

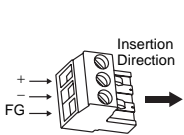
	+	24V
	-	0V
	FG	Grounding Terminal connected to the LT chassis

NOTE

- The power connector (plug) is CA5-DCCNM-01 made by Digital Electronics Corporation or MSTB2,5/3-ST-5,08 made by Phoenix Contact.

When connecting the Power Cord, use the following items when performing wiring. (Items are made by Phoenix Contact.)

Recommended Driver	SZF 1-0.6x3.5 (1204517)
Recommended Pin Terminals	AI 0.75-8GY (3200519) AI 1-8RD (3200030) AI 1.5-8BK (3200043) AI 2.5-8BU (3200522)
Recommended Pin Terminal Crimp Tool	CRIMPFOX ZA 3 (1201882)

■ Connecting the LT Power Cord

- Confirm that the LT unit's Power Cord is unplugged from the power supply.
- Strip the power cord, twist the conductor's wire ends, insert them into the pin terminal and crimp the terminal. Attach the terminal to the power connector (plug).

IMPORTANT

- Use a flat-blade screwdriver (Size 0.6 x 3.5) to tighten the terminal screws. The torque required to tighten these screws is 0.5 to 0.6 N•m [5-7Lb•In.].
 - Do not solder the cable connection. Doing so may damage the unit due to abnormal heat or cause a fire.
- Attach the Power connector (Plug) to the Power Connector.

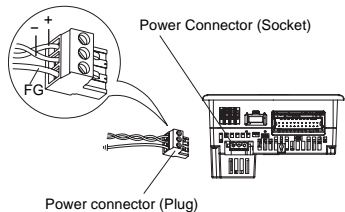
**2. Power Supply Cautions**

- Input and Output signal lines must be separated from the power control cables for operational circuits.
- To improve the noise resistance, be sure to twist the ends of the power cord wires before connecting them to the Power connector (Plug).
- The LT unit's power supply cord should not be bundled with or kept close to main circuit lines (high voltage, high current), or input/output signal lines.
- To reduce noise, make the power cord as short as possible.
- If the supplied voltage exceeds the LT unit's range, connect a voltage transformer.
- Between the line and the ground, be sure to use a low noise power supply. If there is an excess amount of noise, connect a noise reducing transformer.
- The temperature rating of field installed conductors: 75°C only.

IMPORTANT

- Use voltage and noise reducing transformers with capacities exceeding Power Consumption value.
- Must be used with a Class 2 Power Supply. (24VDC)
- Connect a surge absorber to handle power surges.

IMPORTANT

- Be sure to ground the surge absorber (E1) separately from the LT unit (E2). Select a surge absorber that has a maximum circuit voltage greater than that of the peak voltage of the power supply.

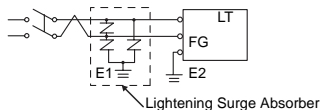

3. Grounding Cautions

- Be sure to create an exclusive ground for the Power Cord's FG terminal. Use a grounding resistance of 100Ω , a wire of 2mm^2 or thicker, or your country's applicable standard.
- The SG (signal ground) and FG (frame ground) terminals are connected internally in the LT unit.
When connecting the SG line to another device, be sure that the design of the system/connection does not produce a shorting loop.
- The grounding wire should have a cross sectional area greater than 2mm^2 . Create the connection point as close to the LT unit as possible, and make the wire as short, as possible. When using a long grounding wire, replace the thin wire with a thicker wire, and place it in a duct.

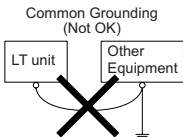
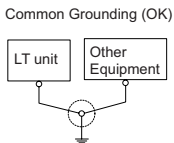
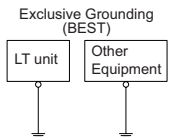

4. Input/Output Signal Line Cautions

- All LT Input and Output signal lines must be separated from all operating circuit (power) cables.
- If this is not possible, use a shielded cable and ground the shield.

5. Wiring Precautions

- To help prevent noise and interference problems, separate all control, communication and power lines by placing them in a separate ducts.

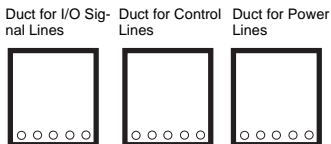

If different wires must be placed in the same duct, separate them with an earthed/grounded divider.

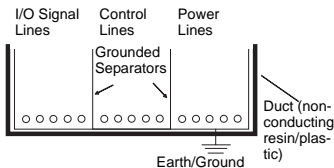

NOTE

- If the lines cannot be separated, use shielded lines and create a ground from the shield line.

IMPORTANT

- Use noise-reducing external wiring methods to increase overall system reliability.
- To prevent power surges or noise interference, use ducts to separate all DC I/O or current circuit wires from communication cables.

- To prevent malfunctions due to noise, communication cables must be wired separately from high-frequency lines and power lines such as high-voltage lines, high-current lines, and inverters.

To prevent the USB cable from coming off

IMPORTANT

- When using USB Host Interface in Hazardous Locations provided in ANSI/ISA-12.12.01, please fix the USB cable with the USB Holder. If it's not fixed so that the connector on the LT's side and the PLC's side cannot come out, the USB Host Interface cannot be used in the Hazardous Locations.

■ Attaching the USB Holder

- (1) Before starting the procedure, orient the two tabs on both sides of the USB Holder in the direction of the arrows in the figure and remove the USB Cover.

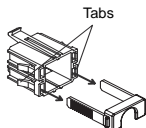

- (2) With the main unit display part positioned so that it is facing down, attach the USB holder to the USB host interface. Do this by inserting the picks on the USB holder itself into the attachment holes on the main unit. Insert the upper hook first.

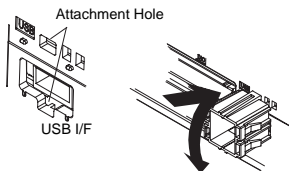

- (3) Insert the USB cable into the USB Host Interface.

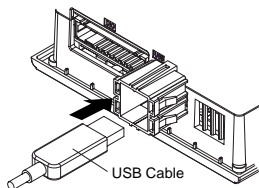

- (4) Attach the USB cover to the USB host interface. Insert the USB cover into the tab of the USB holder.

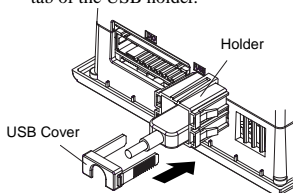

IMPORTANT

- Insert the USB cover in the orientation shown in the illustration above.

■ Removing the USB Holder

- (1) Lift up the tab of the USB holder and then remove the USB cover as shown below.

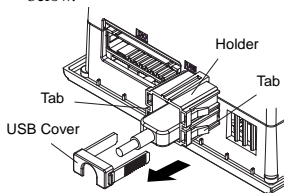

- (2) After removing the USB cable, remove the picks pushing the USB holder from both top and bottom.

Installation prerequisites for standards

For the detailed certification's information, refer to the Pro-face Home page.

<Cautions>

Be aware of the following items when building the LT into an end-use product:

- The LT unit's rear face is not approved as an enclosure. When building the LT unit into an end-use product, be sure to use an enclosure that satisfies standards as the end-use product's overall enclosure.
- The LT unit must be used indoors only.
- Install and operate the LT with its front panel facing outwards.
- If the LT is mounted so as to cool itself naturally, be sure to install it in a vertical panel. Also, it's recommended that the LT should be mounted at least 100mm away from any other adjacent structures or machine parts. The temperature must be checked on the final product in which the LT is installed.
- For use on a flat surface of a Type 4X (Indoor Use Only) and / or Type 13 Enclosure.

Hazardous Locations - Compliance and Handling Cautions *1

- (1) Suitable for use in Class I, Division 2, Groups A, B, C, and D Hazardous Locations, or Non-Hazardous Locations only.
- (2) "WARNING: Explosion hazard-substitution of any components may impair suitability for Class I, Division 2".
- (3) WARNING: Explosion hazard-when in hazardous locations, turn OFF power before replacing or wiring modules.
- (4) "WARNING: Explosion hazard-do not disconnect equipment unless power has been switched off or the area is known to be Non-Hazardous".
- (5) In the case of use in Hazardous Locations, be sure to check that the externally connected unit and each interface have

been fixed with screws and locked. In Hazardous Locations, it's impossible to insert or pull the cable from the applicable port. Be sure to check that the location is Non-Hazardous before inserting or pulling it.

- *1 LT3201-A1-D24-K/LT3201-A1-D24-C units with revision code "B" or later are all Hazardous Locations compliant.

(SEE →) *Revision (page 15)*

CE Marking

- LT3201-A1-D24-K/LT3201-A1-D24-C units are CE marked, EMC compliant products.

For the detailed information, be downloaded and refer the Declaration of Conformity from Pro-face Home Page.

Revision

The revision number of the LT is shown in the label affixed to the LT. In the example shown below, an asterisk "*" is displayed in the position where "A" should be, meaning "Rev. A".



Inquiry

Do you have any questions about difficulties with this product?
Please access our site anytime that you need help with a solution.

<http://www.pro-face.com/otasuke/>



SCIGATE AUTOMATION (S) PTE LTD
No.1 Bukit Batok Street 22 #01-01 Singapore 659592
Tel: (65) 6561 0488 Fax: (65) 6562 0588
Email: sales@scigate.com.sg Web: www.scigate.com.sg
Business Hours: Monday - Friday 8.30am - 6.15pm

Note

Please be aware that Digital Electronics Corporation shall not be held liable by the user for any damages, losses, or third party claims arising from the uses of this product.

Digital Electronics Corporation
8-2-52 Nanko-higashi
Suminoe-ku, Osaka 559-0031
JAPAN
TEL: +81-(0)6-6613-3116
FAX: +81-(0)6-6613-5888
<http://www.pro-face.com/>

© Copyright 2006 Digital Electronics Corporation. All rights reserved.
PFX104833C .LT3201A-MT03E-BTH
2012.3 JM/C